



1200 SERIES LID LIFT

OPERATOR'S / INSTRUCTION MANUAL
W/ PARTS IDENTIFICATION

2565-953 • 03/2017



YETTER MANUFACTURING CO.
FOUNDED 1930

Colchester, IL 62326-0358
Toll free: 800/447-5777
309/776-3222 (Fax)

Website: www.yetterco.com
E-mail: info@yetterco.com

YETTER

FOREWORD

You've just joined an exclusive but rapidly growing club.

For our part, we want to welcome you to the group and thank you for buying a Yetter product.

We hope your new Yetter implement will help you achieve both increased productivity and increased efficiency so that you may generate more profit. This operator's manual has been designed into six major sections.

Foreword, Safety Precautions, assembly instructions, Operation, parts identification and troubleshooting.

It is important the owner/operator knows the implement model number and serial number. Write the serial and model number in the space provided and use it in all correspondence when referring to the implement.

 Throughout the manual references may be made to left side and right side. These terms are used as viewed from the operator's seat facing the front of the tractor.

 This **SAFETY ALERT SYMBOL** indicates important safety messages in the manual. When you see this symbol, be alert to the possibility of **PERSONAL INJURY** and carefully read the message that follows.

The word **NOTE** is used to convey information that is out of context with the manual text. It contains special information such as specifications, techniques, reference information and other information of a supplementary nature.

The word **IMPORTANT** is used in the text when immediate damage will occur to the machine due to improper technique or operation. Important will apply to the same information as specified by note only of an immediate and urgent nature.

It is the responsibility of the user to read the operator's manual and comply with the safe and correct operating procedure and to lubricate and maintain the product according to the maintenance schedule in the operator's manual.

The user is responsible for inspecting his machine and for having parts repaired or replaced when continued use of the product would cause damage or excessive wear to the other parts.

It is the user's responsibility to deliver his machine to the Yetter dealer who sold him the product for service or replacement of defective parts that are covered by the warranty policy.

If you are unable to understand or follow the instructions provided in the publication, consult you local Yetter dealer or contact:

YETTER MANUFACTURING CO.

309/776-4111

800/447-5777

309/776-3222 (FAX)

Website: www.yetterco.com

E-mail: info@yetterco.com

WARRANTY POLICY

Yetter Manufacturing warrants all products manufactured and sold by it against defects in material. This warranty being expressly limited to replacement at the factory of such parts or products as will appear to be defective after inspection. This warranty does not obligate the Company to bear cost of labor in replacement of parts. It is the policy of the company to make improvements without incurring obligations to add them to any unit already sold. No warranty is made or authorized to be made, other than herein set forth. This warranty is in effect for one year after purchase.

Model Number: _____

Dealer: _____

Yetter Manufacturing warrants its own products only and cannot be responsible for damage to equipment on which it is mounted.

SAFETY

A brief description of signal words that may be used in this manual:

CAUTION: Used as a general reminder of good safety practices or to direct attention to unsafe practices.

WARNING: Denotes a specific potential hazard.

DANGER: Denotes the most serious specific potential hazard.

SAFETY PRECAUTIONS

You can make your farm a safer place to live and work if you observe the safety precautions given. Study these precautions carefully and insist that those working with you and for you follow them.

Finally, remember this: an accident is usually caused by someone's carelessness, neglect or oversight.



WARNING

Never clean, lubricate or adjust a machine that is in motion. Always lower or block the implement before performing service.

If the machine must be serviced in the raised position, jack or block it up to prevent it from accidentally falling and injuring someone.

Do not allow riders on the tractor or implement.

Use speeds and caution dictated by the terrain being traversed. Do not operate on any slope steep enough to cause tipping or loss of control.

Be sure all personnel are clear of the immediate area before operating.

Read and understand the operator's manual and require all other persons who will operate the equipment to do the same.

Be familiar with all tractor and implement controls and be prepared to stop engine and implements quickly in an emergency.



CAUTION

Consult your implement and tractor operator's manual for correct and safe operating practices.

Beware of towed implement width and allow safe clearance.

FAILURE TO HEED MAY RESULT IN PERSONAL INJURY OR DEATH.

TABLE OF CONTENTS



FOREWORD.....	2
SAFETY.....	3
TABLE OF CONTENTS/BOLT TORQUE.....	4
GENERAL INFORMATION.....	5
LID LIFT ASSEMBLY INSTRUCTION.....	6 – 8
AIR COMPRESSOR INSTALLATION.....	9 – 10
ON/OFF VALVE INSTALLATION.....	10
OEM AIR COMPRESSOR PLUMBING.....	11
LID LIFT AIRLINE PLUMBING.....	12 - 14
OPERATION.....	15
MAINTENANCE.....	16
PARTS IDENTIFICATION.....	17 - 20
TROUBLESHOOTING.....	21

BOLT TORQUE

READ THESE INSTRUCTIONS FIRST:



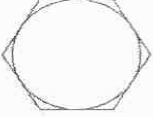
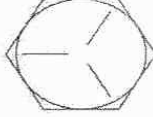

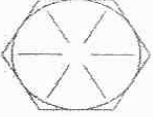

1. Improperly tightened bolts will result in damage, breakage, expense, and down time.
2. Always replace bolts with the specified grade and type.
3. Torque properly before first use of the machine and every 2-4 hours of use until you are sure bolts are staying tight.
4. The chart below is a guide for proper torque. Use it unless a specified torque is called out elsewhere in the manual.
5. Torque is the force you apply to the wrench handle or the cheater bar, times the length of the handle or bar.
6. Use a torque wrench whenever possible.

The following table shows torque in ft. lbs.

BOLT DIA. AND THREADS PER INCH	 GRADE 2	 OR  GRADE 5 A-325	 GRADE 8
1/4	6	10	14
5/16	12	20	30
3/8 – 16	25	35	50
7/16 – 14	35	55	80
1/2 – 13	55	85	125
9/16 – 12	75	125	175
5/8 – 11	105	170	235
3/4 - 10	185	305	425
7/8 – 9	170	445	690
1-8	260	670	1030
1 1/8 – 7	365	900	1460
1 1/4 - 7	515	1275	2060
1 3/8 – 6	675	1675	2700
1 1/2 - 6	900	2150	3500
1 3/4 – 5	1410	3500	5600

GENERAL INFORMATION

Examine all equipment carefully for damage or shortages.

<u>PART NUMBER</u>	<u>DESCRIPTION</u>	<u>PHOTO</u>
1200-020	Air Compressor Kit ----->	N/A
1200-021	24 Row or Less Fitting & Tubing Kit ----->	N/A
1200-030	Planter Seed Box Latch Kit ----->	
1200-060	Compressor Wiring Kit ----->	N/A
1200-102	Mount Bolt Bag ----->	
1200-103	Lid Lift Assembly ----->	
1200-104	Valve & Regulator Kit ----->	
1200-147	(10) 1/4" PC Tees, Bagged ----->	
1200-322	Air Cylinder ----->	
1200-337	Black Tubing, 1/4", 100ft Roll ----->	
1200-338	Valve Mount ----->	
1200-339	SMC Valve ----->	
1200-340	0 – 150psi 1/8NPT Regulator ----->	
1200-342	3/8PC to 1/4PC Tee Reducer ----->	

LID LIFT ASSEMBLY INSTRUCTIONS

WARNING: NEVER WORK UNDER THE EQUIPMENT WHILE IN A RAISED POSITION WITHOUT USING SAFETY LOCK UPS. FAILURE TO DO SO MAY LEAD TO PERSONAL INJURY OR DEATH.

Tools Required: Grinder with cut off wheel, tape measure, pencil, drill, 11/32" drill bit, ratchet/impact, 1/2" socket, 1/2" wrench

STEP 1: Remove the lid from the seed box, clamp the lid upside down on a table/workbench, & cut off the locking tabs on the underneath side of the lid, test fit to ensure smooth operation. Put the lid back on the seed box when finished.



STEP 2: Place the seed box/lid on a table/workbench & secure the seed box/lid to the table with clamps. On the front of the seed box near the top, use a tape measure to find the center, side to side, and make a mark using a pencil.

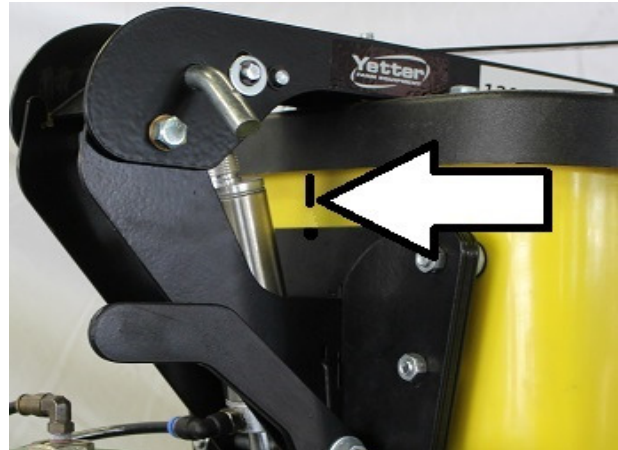
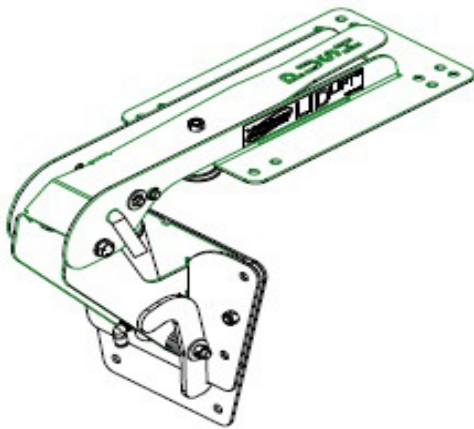

STEP 3: Install the 1200-103 Lid Lift Assembly on the seed box/lid as shown in the picture below. The lid bracket & seed box bracket should be at 90 degree angle when mounted properly. Before drilling or marking the holes, measure the distance from the lid to the top of the seed box mount to ensure it is level.

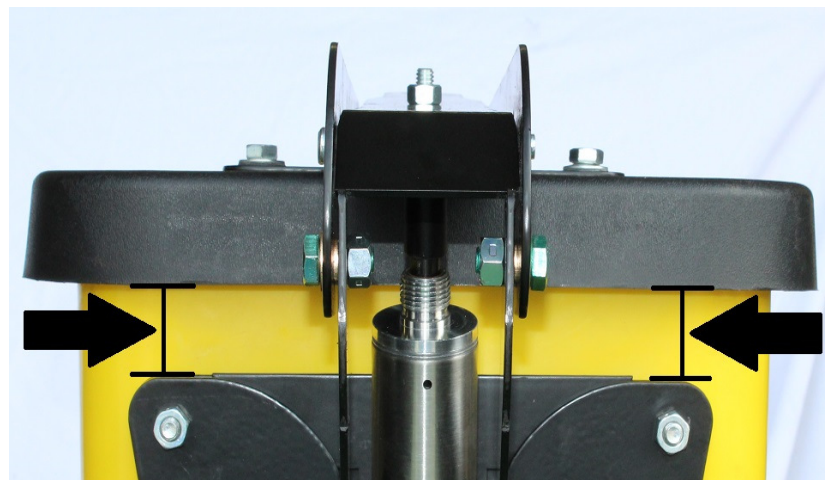

LID LIFT ASSEMBLY INSTRUCTIONS CONT'D

STEP 4: Hold the 1200-103 in place or use clamps if necessary while drilling the first hole (11/32 bit) on the top left (TL 1). Insert a bolt through bracket & the drilled TL 1 hole to act as an anchor while drilling the next hole. Measure the distance between the lid & top of the bracket before drilling the top right (TR 2) hole to make sure the bracket is still even. After the top right hole is drilled, insert a bolt through the bracket & the drilled TR 2 hole. Drill the next 2 holes, either using the middle set of holes or the bottom set of holes.

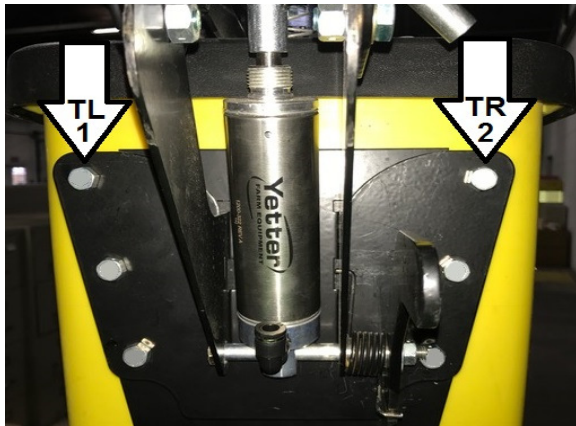

STEP 5: Mount the 1200-103 assembly to the seed box. Install 1) 2502-206 bolt through each hole on the mount plate. Put 1) 1200-313 spacer on each bolt behind the mount plate. Place 1) 1200-314 washer with neoprene seal behind each spacer, the neoprene side of the washer toward the seed box. Insert the bolts through the holes on the front of the seed box. Place 1) 1200-314 washer with neoprene seal on each bolt on the inside of the seed box, neoprene side of the washer toward the seed box. Install 1) 2520-205 5/16 lock nut on each bolt & tighten until neoprene compresses slightly.

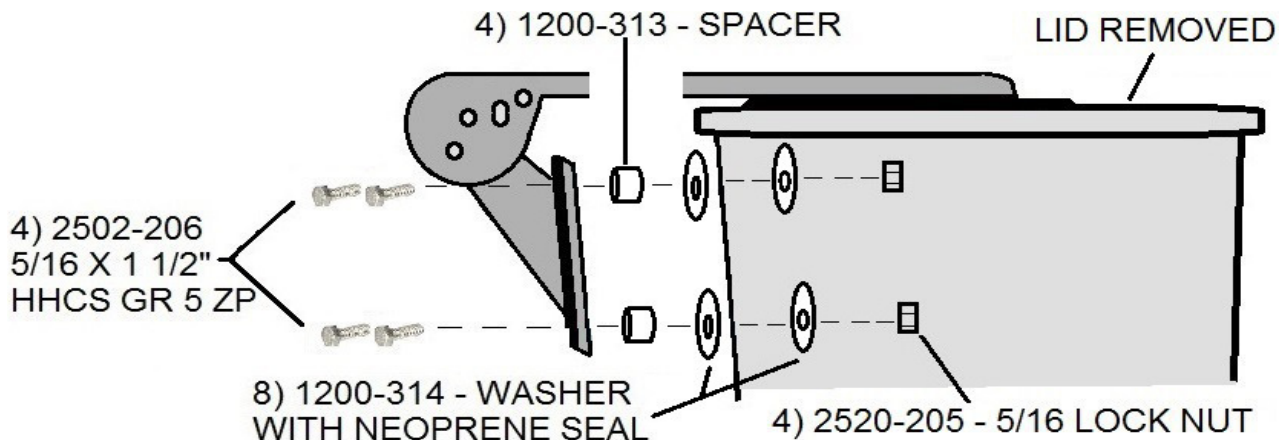

STEP 6: Put the lid back on the seed box & mark the 4 holes on the lid using the lid mount as a template. Measure & verify that the webbing support under the lid does not interfere with where the holes need to be. Select another hole on the lid mount if necessary. There needs to be room beside the webbing support for the neoprene washer. Drill the holes in the lid while pushing the lid mount toward the rear of the seed box. This helps keep the back of the lid sealed against the seed box. To help keep the lid mount anchored, insert a bolt through the lid mount and lid after each hole is drilled. If the webbing interference cannot be avoided, grind down enough webbing support to fit.

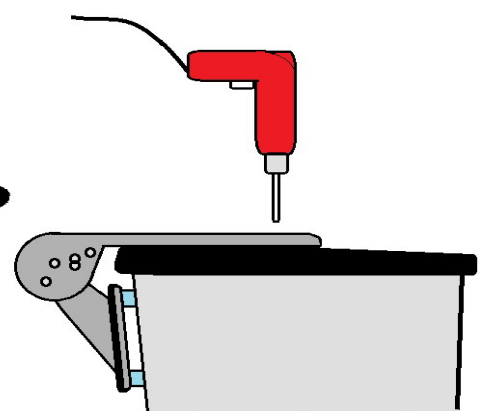
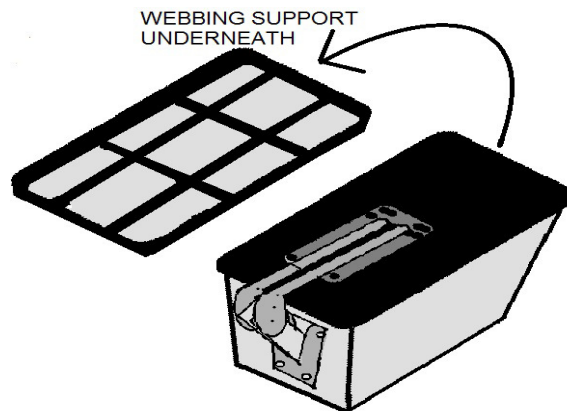

LID LIFT ASSEMBLY INSTRUCTIONS CONT'D

STEP 7: Mount the seed box lid to the lid mount. Insert 1) 2502-201 – 5/16 X 3/4 bolts through each hole on the lid plate. Insert 1) 1200-314 – 5/16 washer with neoprene seal on each bolt between the lid plate & the lid, neoprene seal side of the washer towards the lid. Insert the bolts through the holes on the lid. Insert 1) 1200-314 – 5/16 washer with neoprene seal over each bolt's thread, neoprene seal against the lid. Install 1) 2520-205– 5/16 lock nut on each bolt & tighten until neoprene compresses slightly.

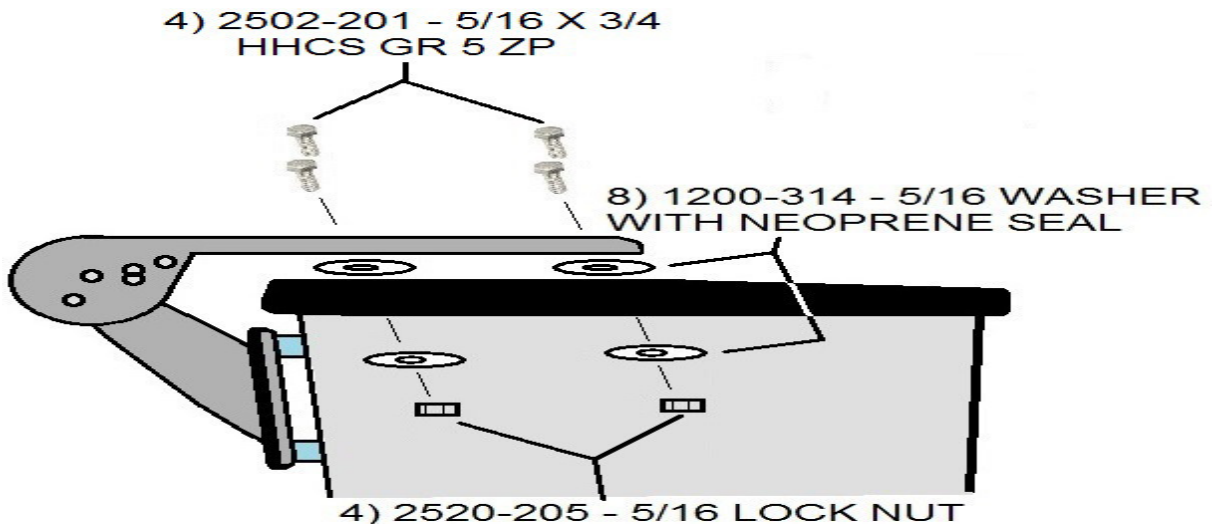

STEP 8: Manually open the lid lift assembly to verify the lid lift assembly open/closes properly and that the latch locks when closed to prevent the lid from opening. Attach the seed box assembly back on the row unit it came off of. Manually open the lid lift assembly to check for clearance with other attachments on the planter such as fertilizer tanks or other fertilizer system components, row unit down force mechanisms, bulk fill planter steps, etc.

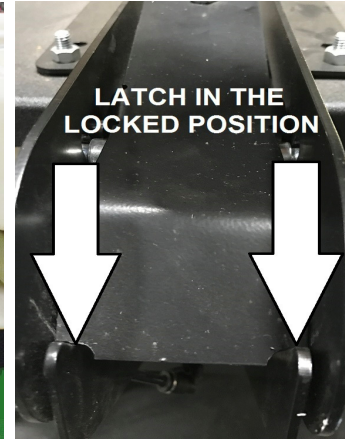

PICTURES OF OTHER PLANTER ATTACHMENTS TO CHECK CLEARANCE

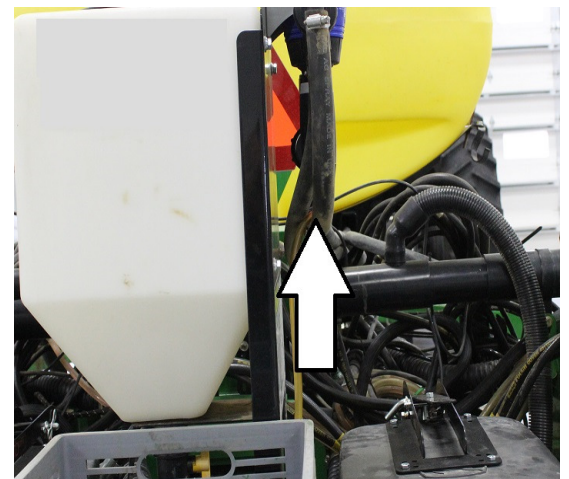
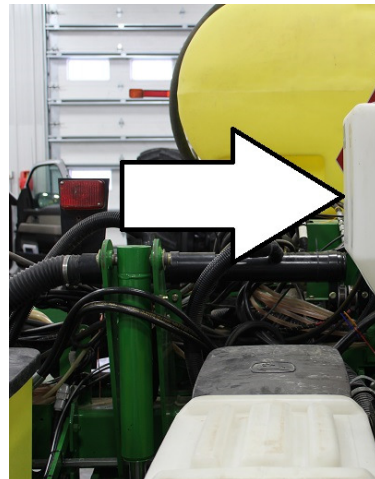
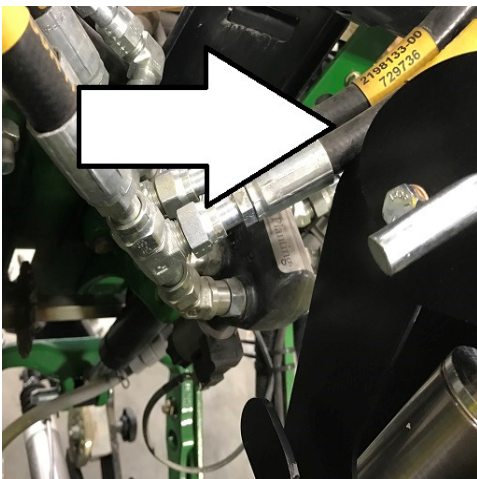

1200-350 AIR COMPRESSOR ASSEMBLY INSTRUCTIONS

Yetter 1200-350 Compressor Assembly

STEP 1: Mount the compressor mount kit on the planter in an area with clearance while planting and that also has clearance while folding/unfolding. A few mounting location options would be: A) the **DRAFT TUBE** by the planter hitch, B) the outer **NON-TELESCOPING TONGUE**, or C) the **MAIN TOOLBAR** that the row units are mounted to.

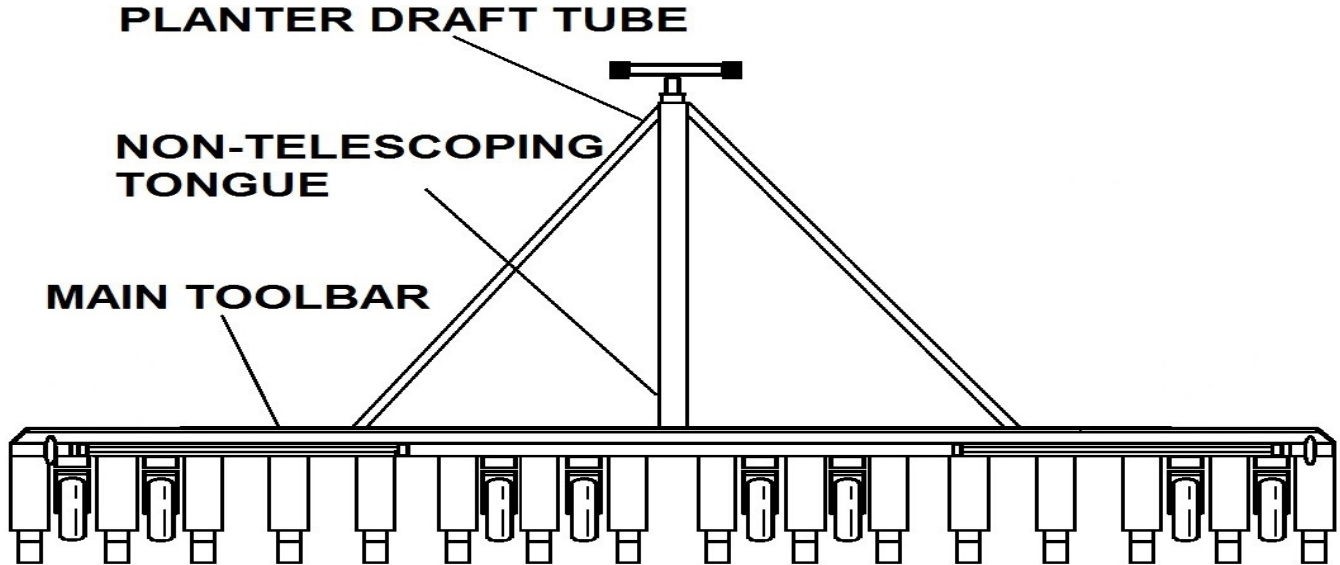

STEP 2: Install the 2940-166 on the tractor battery, red cable to the positive post & black cable to the negative post. Mount or secure the breaker to avoid short circuit. Install 2940-167 (10') & 2940-168 (20') power cable extensions from the Anderson connector on the 40A breaker cable to the Anderson connector on the compressor labeled B. Try to have a connection near the hitch for ease of attaching/detaching the planter from the tractor. Zip tie the power cables as needed.



1200-350 AIR COMPRESSOR ASSEMBLY INSTRUCTIONS

STEP 3: Install the female connector of the 2940-154 at the compressor (labeled A) & route to the interior of the tractor cab. Find a suitable location in the cab to mount or place the 1200-360 cab switch & harness. Once the cab switch is secured in place, install the male connector of the 2940-154 to the female connector of the switch (labeled C).

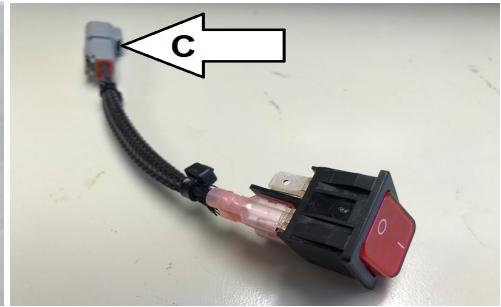
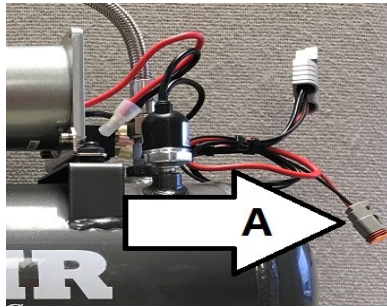

ON/OFF VALVE & REGULATOR ASSEMBLY INSTRUCTIONS

STEP 1: Install the 1200-104 Valve & Regulator Assembly on the planter by placing the open hole on the mounting tab over the threads on row 1's U-bolt on the top side of the toolbar. Use the provided flanged nut (flat flange (labeled 1) used on John Deere planters, serrated flange (labeled 2) on all other OEM planters) & 15/16 wrench to firmly tighten the mounting tab in the upright position as shown in the pic below. This mounting position allows the operator to easily open/close box lids for checking/filling seed boxes.

STEP 2: Install 1/4" black airline from the 1/4" fitting on the compressor to the inlet fitting on the 1200-021 Open/Close valve kit labeled B.

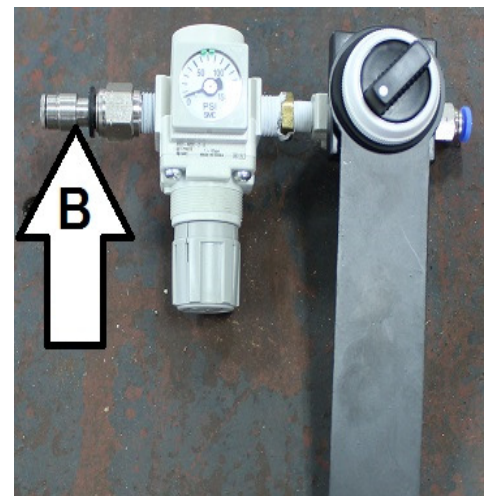
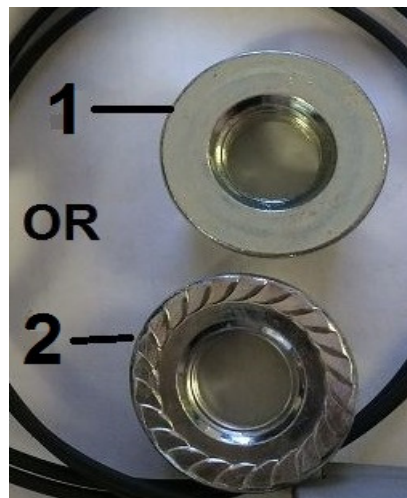

OEM AIR COMPRESSOR PLUMBING

Plumbing into Yetter 2940 Electric or 2940 Yetter Hydraulic Air Compressor Assemblies

STEP 1: Drain all tank pressure.

STEP 2: Install a tee into the airline downstream of the water separator. (labeled A)

STEP 3: Route & install airline from the tee installed in step 2 to the ON/OFF valve assembly. (labeled B)

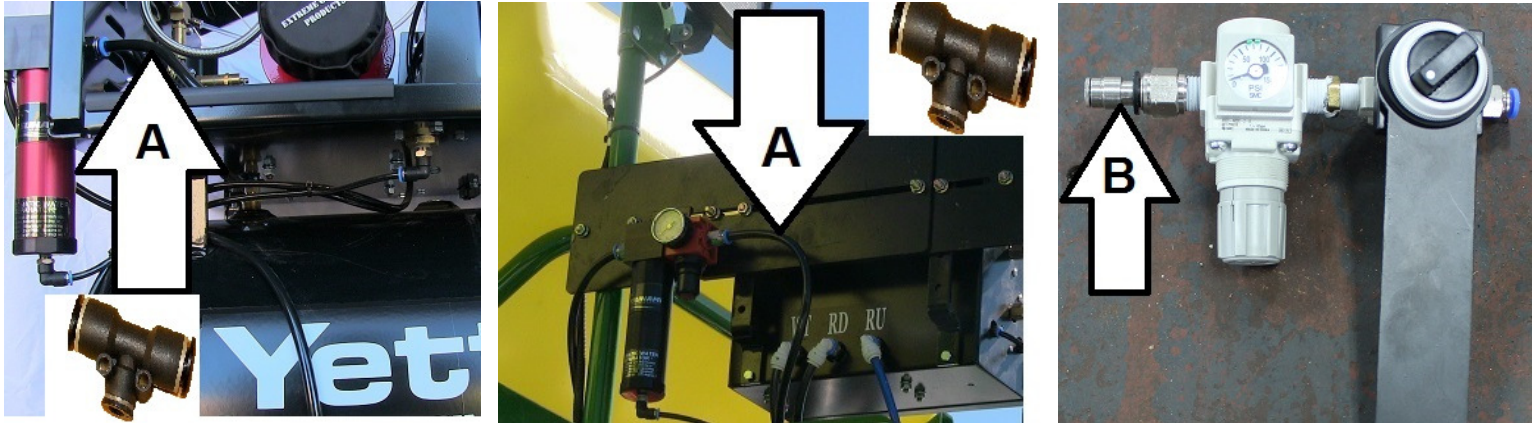

Plumbing into John Deere's Electric & Hydraulic Air Compressor Assembly

STEP 1: Drain all tank pressure.

STEP 2: Remove the plug/gauge from the compressor manifold (labeled A).

STEP 3: If compressor manifold has a plug, install the 2940-423 air fitting where the plug was. If the compressor manifold has a gauge, install the 2940-374 tee so that the gauge can still be used. Wrap all male threads with Teflon tape before installation.

STEP 4: Route & install airline from the air fitting at the compressor manifold to the ON/OFF valve assembly (labeled B).

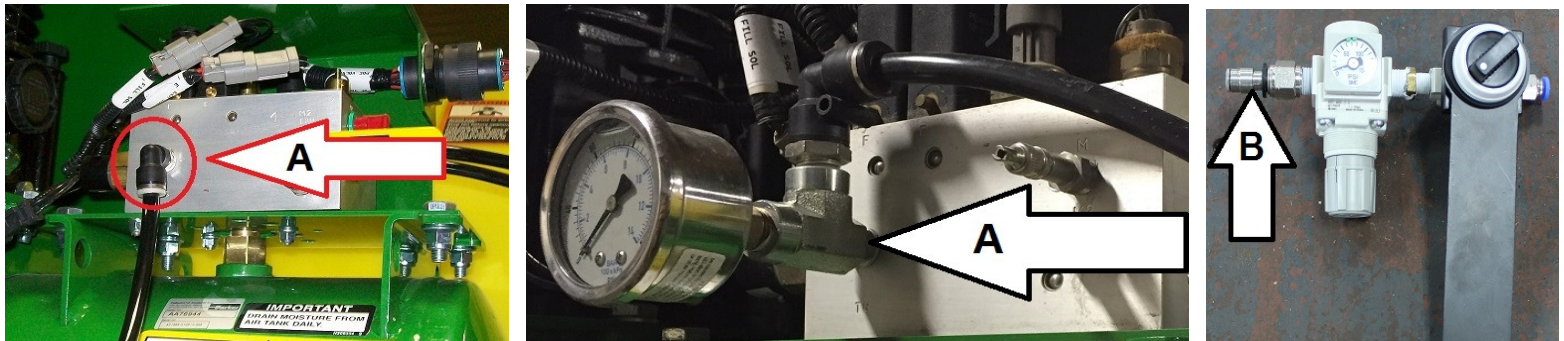

Plumbing into Precision Planting's Electric & Hydraulic Air Compressor Assembly

STEP 1: Drain all tank pressure.

STEP 2: Install a tee into the airline downstream of the water separator. (labeled A)

STEP 3: Route & install airline from the tee inside the compressor housing to the ON/OFF valve assembly.

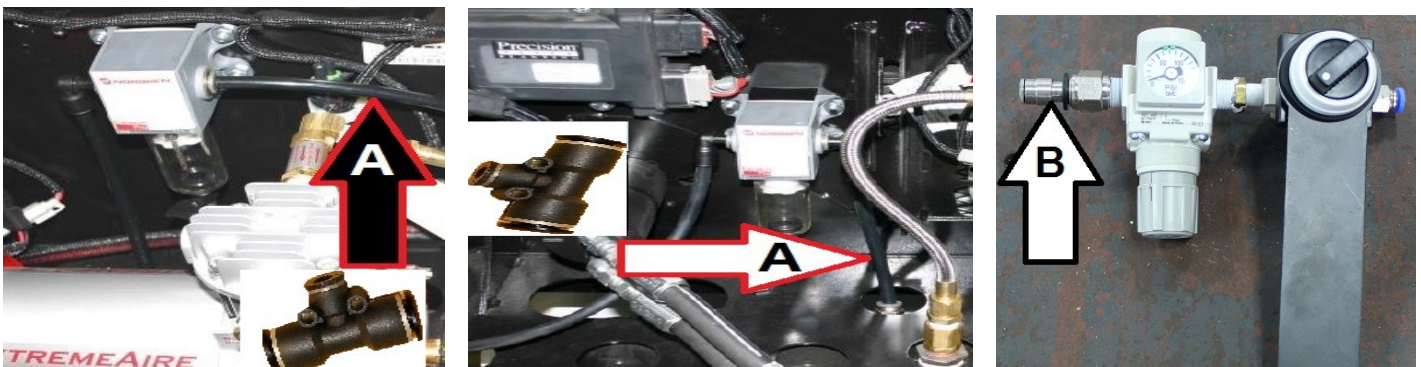

AIRLINE PLUMBING ASSEMBLY INSTRUCTIONS

SINGLE RANK PLANTERS

Below are airline plumbing diagrams for some single rank planters to help you better under the plumbing installation process. Follow other airline, electrical/communication cables, & hydraulic hoses, noting their path for folding the planter, when routing Lid Lift airline on the main toolbar.

- STEP 1: Using a new roll of ¼" airline at row 1, take the end of the airline & route the airline on the toolbar & install the end of the airline into the last row on the planter lid lift air cylinder. On a 24 row planter for example, install the airline on row 24's lid lift air cylinder.
- STEP 2: Trace this ¼" airline back to row 1 installing a Tee at each row. On a 24 row for example, install tee at rows 2 – 23.
- STEP 3: At row 1, cut the ¼" airline from the roll, long enough that the airline can be installed in the open/close valve assembly output fitting. Install a tee at row 1. Install airline from the tee into row 1's air cylinder.
- STEP 4: Install ¼" airline into each air cylinder on rows 2 – 23 & then route the airline to the Tee for that row & install. For example, install the ¼" airline into the air cylinder on row 2, cut the airline so that the airline reaches the Tee installed for row 2 (leave some slack), & install the airline into the Tee.
- STEP 5: Visually inspect all the ¼" airline installed & zip tie as needed to keep airline away from pinch & wear points.

12 ROW

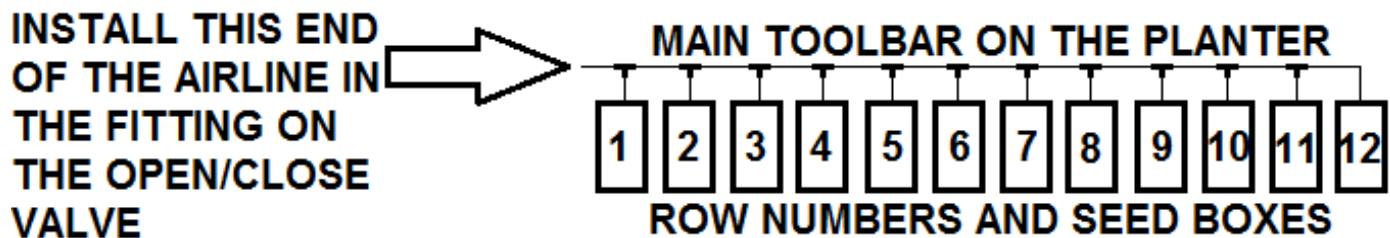

16 ROW

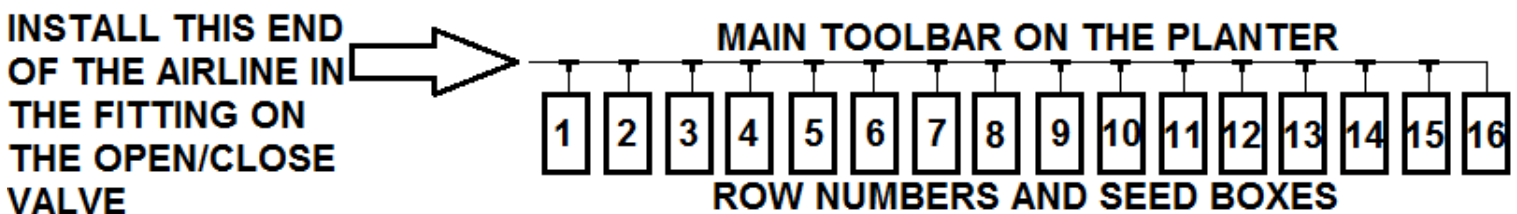

24 ROW

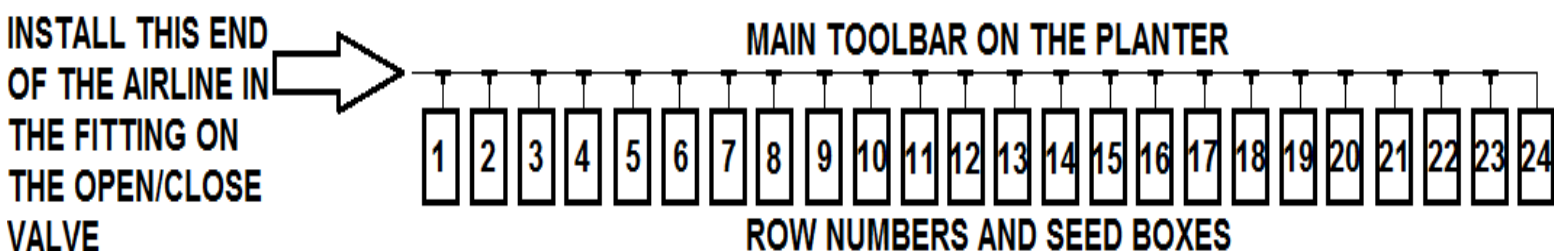

AIRLINE PLUMBING ASSEMBLY INSTRUCTIONS

DOUBLE RANK CENTER PIVOT PLANTERS

Below are airline plumbing diagrams for some center pivot, 2 rank planters to help you better under the plumbing installation process. Follow other airline, electrical/communication cables, & hydraulic hoses when routing airline on the main toolbar.

- STEP 1: Using a new roll of ¼" airline & starting at corn row 1, take the end of the airline & route the airline down the toolbar installing the end of the airline into the last corn row on the planter's lid lift air cylinder. On a 12/23 split row planter for example, install the airline on corn row 12's lid lift air cylinder.
- STEP 2: Trace this ¼" airline back to corn row 1 installing a Tee at each corn row. On a 12/23 split row planter for example, install a tee at corn rows 2 – 11.
- STEP 3: At corn row 1, cut the ¼" airline from the roll, long enough that the airline can be installed in the air fitting on the air cylinder on corn row 1. Install the ¼" airline into air fitting of the air cylinder on corn row 1.
- STEP 4: Install ¼" airline from the fitting on the air cylinder for each corn row to the Tee for that row. On a 12/23 for example, install airline from the fitting on the air cylinder on corns 2 – 11 to the tee for that row.
- STEP 5: Starting at bean row 1, route airline on the toolbar following the same path as other pneumatic lines, electrical/communication cables, & hydraulic hoses. Install the end of the airline into the last bean row's lid lift air cylinder. On a 12/23 row planter for example, install the airline on bean row 11's lid lift air cylinder.
- STEP 6: Trace the airline from the last bean row to bean row 1 installing a tee at each bean row. On a 12/23 split row planter for example, install a tee at bean rows 2 – 10.
- STEP 7: At bean row 1, cut the ¼" airline from the roll, long enough that the airline can be installed in the air fitting on the air cylinder on row 1. Install the ¼" airline into air fitting of the air cylinder on row 1.
- STEP 8: Install ¼" airline from the fitting on the air cylinder for each bean row to the Tee for that row. On a 12/23 split row planter for example, install airline from the fitting on the air cylinder on corns 2 – 11 to the tee for that row.
- STEP 9: Install a Tee in the airline for the corn rows & bean rows. Install airline between the 2 Tees to connect the 2 sets of airline.
- STEP 10: Install a Tee at the first row of the planter nearest to the ON/OFF valve. Install airline between the open end of the Tee and the outlet on the ON/OFF valve.

8/15 SPLIT ROW

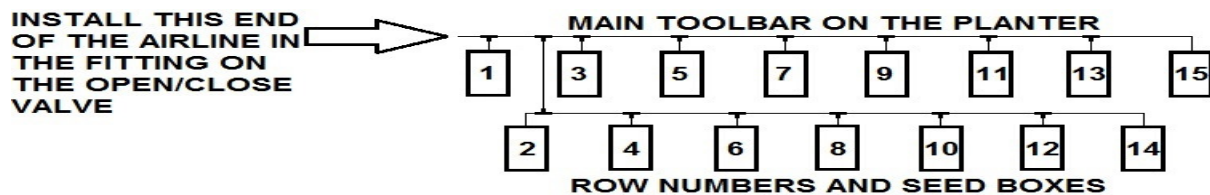

12/23 SPLIT ROW

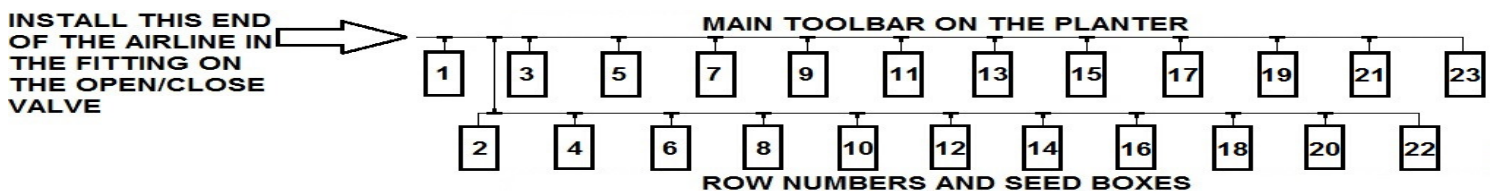

16/31 SPLIT ROW

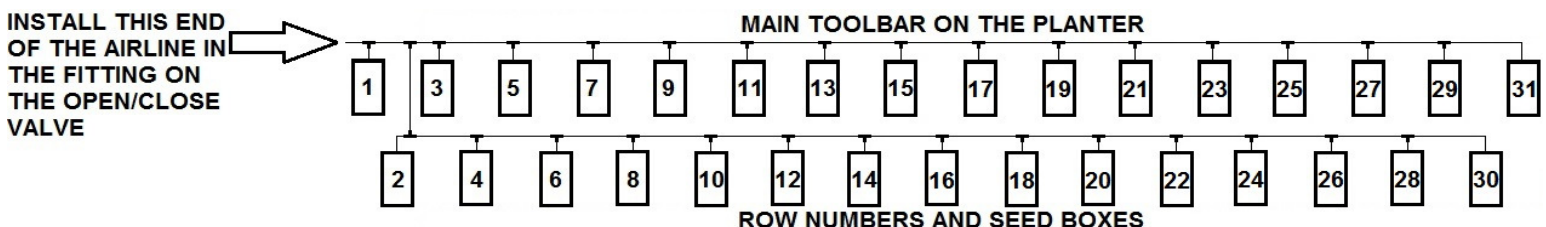

AIRLINE PLUMBING ASSEMBLY INSTRUCTIONS

DOUBLE RANK FRONT FOLD PLANTERS

Below are airline plumbing diagrams for some front fold, 2 rank planters to help you better under the plumbing installation process. Follow other airline, electrical/communication cables, & hydraulic hoses when routing airline on the main toolbar.

Front Rank

- STEP 1: Starting on the outside row of the left wing, route & install the airline into the lid lift air cylinder on the last row or inside row on the left wing. Trace this ¼" airline back to the outside row on the left wing installing a Tee at each row. When returned to the outside row, cut the airline to length & install the end into the air cylinder. At each row on the left wing with a tee, cut airline to length. Install 1 end into the air cylinder. Install the other end into the tee for that row.
- STEP 2: Starting on the outside row of the right wing, route & install the airline into the lid lift air cylinder on the last row or inside row on the right wing. Trace this ¼" airline back to the outside row on the right wing installing a Tee at each row. When returned to the outside row, cut the airline to length & install the end into the air cylinder. At each row on the right wing with a tee, cut airline to length. Install 1 end into the air cylinder. Install the other end into the tee for that row.
- STEP 3: Starting at the row on the left side of the center section, route & install the airline into the lid lift air cylinder at the row on the right side of the center section. Trace this ¼" airline back to the row on the left side of the center section installing a Tee at each row. When returned to the row on the left side of the center section, cut the airline to length & install the end into the air cylinder. At each row on the center section with a tee, cut airline to length. Install 1 end into the air cylinder. Install the other end into the tee for that row.
- STEP 4: Install a Tee in the airline next to the first row on left wing. Install airline between the Tee & the ¼" fitting on the valve.

Back Rank

- STEP 5: Starting on the outside row of the left wing, route & install the airline into the lid lift air cylinder on the last row or inside row on the left wing. Trace this ¼" airline back to the outside row on the left wing installing a Tee at each row. When returned to the outside row, cut the airline to length & install the end into the air cylinder. At each row on the left wing with a tee, cut airline to length. Install 1 end into the air cylinder. Install the other end into the tee for that row.
- STEP 6: Starting on the outside row of the right wing, route & install the airline into the lid lift air cylinder on the last row or inside row on the right wing. Trace this ¼" airline back to the outside row on the right wing installing a Tee at each row. When returned to the outside row, cut the airline to length & install the end into the air cylinder. At each row on the right wing with a tee, cut airline to length. Install 1 end into the air cylinder. Install the other end into the tee for that row.
- STEP 7: Starting at the row on the left side of the center section, route & install the airline into the lid lift air cylinder at the row on the right side of the center section. Trace this ¼" airline back to the row on the left side of the center section installing a Tee at each row. When returned to the row on the left side of the center section, cut the airline to length & install the end into the air cylinder. At each row on the center section with a tee, cut airline to length. Install 1 end into the air cylinder. Install the other end into the tee for that row.
- STEP 8: On each section, (left wing, right wing, center section) Tee the front rank and back rank together.

12/23 SPLIT ROW

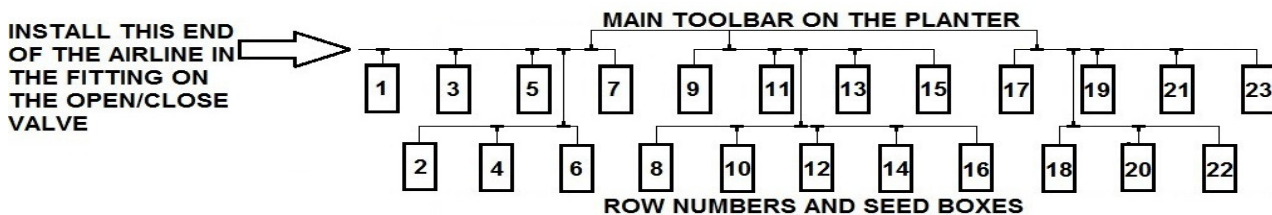

16/31 SPLIT ROW

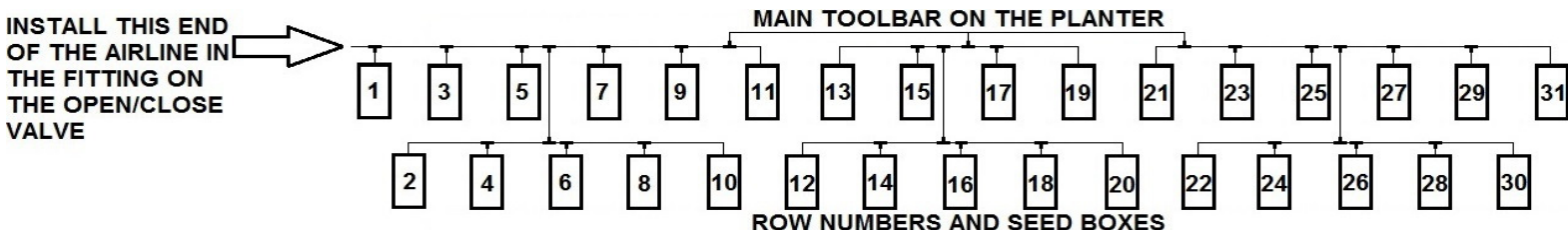

OPERATION

Compressor – Always check the 40A breaker at the battery and that all the power cables are plugged in. Keep the Anderson power connectors clean to ensure proper connection. Flipping the switch in the cab will turn the compressor on. If the compressor doesn't run, it may have enough pressure in the tank. The pressure switch on the compressor engages the compressor anytime the tank psi is 90 or below. The pressure switch disengages the compressor at 120psi.

Open Breaker



Closed Breaker



Compressor Switch

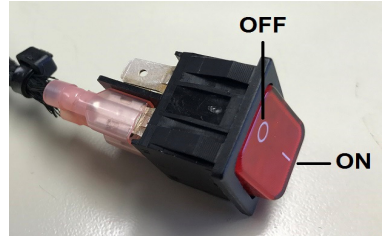

Pressure Switch



OPEN/CLOSE Valve – The ON/OFF Valve has 2 simple functions: 1) supplying air to the Lid Lift cylinder on each row to raise the hopper lid by turning the switch to open or exhausting the air to the Lid Lift cylinders on each row to lower the hopper lid by turning the switch to closed. 2) a regulator is attached to the ON/OFF Valve to set the amount of pressure sent to all Lid Lift cylinders. The regulator should be set so that the air cylinder raises and lowers each lid smoothly, typically in the range of 40 – 70psi.

Valve Position Closed – Lids Down

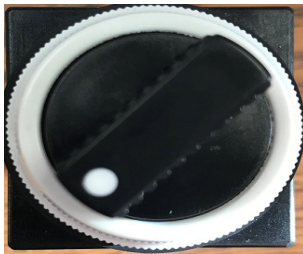

Valve Position Open – Lids Raised

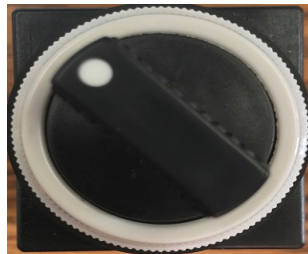

Regulator



Lid Lift Opening/Closing – When the valve is flipped to OPEN & the lids raise, you may notice that the lids do not all lift at the same time. The rows closer to the open/close valve will react sooner than those further away from the open/close valve. The same will happen when the valve is switched back to CLOSED, not all lids will shut at the same time. If the compressor source is unable to produce air to raise the lids, simply push the lid handle (labeled A) to release the latch and lift the rear of the lid. The limit pin will need pulled to hold the lid over center for hands free use. The lid can also be completely removed by pulling the latch handle (labeled C) toward the seed box & lifting the lid plate (labeled D) from the seed box mounting plate.

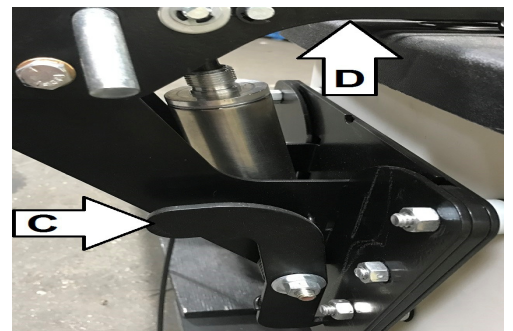
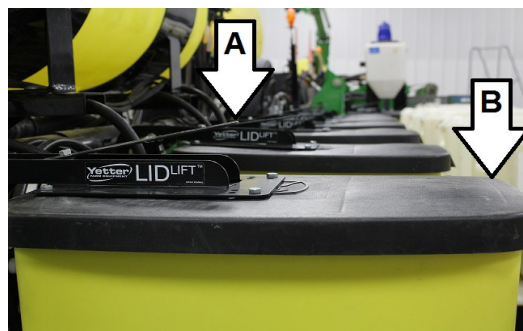

Planter Seed Box Latch Kit – The latch kit is to be used to keep the lid sealed to the seed box during excessive wind speeds. These do NOT need to be latched each time the seed boxes are filled.



MAINTENANCE

Practice Safety

Understand and practice safe service procedures before doing work. Follow ALL the operating, maintenance and safety information in the equipment operator manual. Clear the area of bystanders, especially small children, when performing any maintenance or adjustments. Keep work area clean and dry. Use adequate lighting for the job. Use only tools, jacks and hoists of sufficient capacity for the job.

Never lubricate, service, or adjust machine while it is moving. Keep hands, feet, and clothing from power-driven moving and rotating parts. Disengage all power and operate controls to relieve pressure. Lower equipment to the ground and stop the engine. Remove the key. Wait for all moving parts to stop before servicing, adjusting, repairing or unplugging.

Securely support any machine elements with blocks or safety stands that must be raised for service work.

Keep all parts in good condition and properly installed. Fix damaged equipment immediately. Replace worn or broken parts. Remove any buildup of grease, oil, or debris.

Make sure all guards are in place and properly secured when maintenance work is completed.

Daily Inspection

- Clean the filter on the compressor source
- Drain moisture from the compressor source using the petcock on the tank or water separator assembly
- Inspect the power/communication cables that operate the compressor source
- Inspect the compressor for visually worn parts, unusual noise & odors
- Check for air leaks at the compressor and when air cylinders are activated



CAUTION: To help prevent serious injury or death to you or others caused by unexpected movement, service machine on a level surface. Lower machine to ground or sufficiently lock or block raised machine before servicing. If machine is connected to tractor, engage parking brake and place transmission in "PARK", shut off engine and remove key. If machine is detached from tractor, block wheels and use shop stands to prevent movement.



CAUTION: Do not clean or adjust machine while in motion.

Storing the Equipment

Store the machine in an area away from human activity. Store machine in RAISED position. Install service locks on all wheel cylinders.

At the end of the season, the machine should be thoroughly inspected and prepared for storage. Repair or replace any worn or damaged components to prevent down time at the start of the next season. Store machine under cover with all parts in operating condition.

- Clean machine thoroughly to remove all dirt, debris, fertilizer spatter, & crop residue, which would hold moisture & cause rusting.
- Inspect machine for worn or broken parts. See your Yetter Farm Equipment dealer during the off-season so that parts or service can be acquired when machine is not needed in the field.
- Paint all parts which are chipped or worn and require repainting.
- Store machine in a clean, dry place with the planting unit out of the sun.
- If the machine cannot be stored inside, cover with a waterproof tarpaulin and tie securely in place.
- Do not allow children to play on or around the machine

1200-020 PARTS IDENTIFICATION

ITEM	PART NUMBER	DESCRIPTION	QUANTITY
1			
2			
3			
4			
5			

1200-030 PARTS IDENTIFICATION

ITEM	PART NUMBER	DESCRIPTION	QUANTITY
1			
2			
3			
4			
5			

1200-060 PARTS IDENTIFICATION

ITEM	PART NUMBER	DESCRIPTION	QUANTITY
1			
2			
3			
4			
5			

1200-086 PARTS IDENTIFICATION

ITEM	PART NUMBER	DESCRIPTION	QUANTITY
1			
2			
3			
4			
5			

1200-111 PARTS IDENTIFICATION

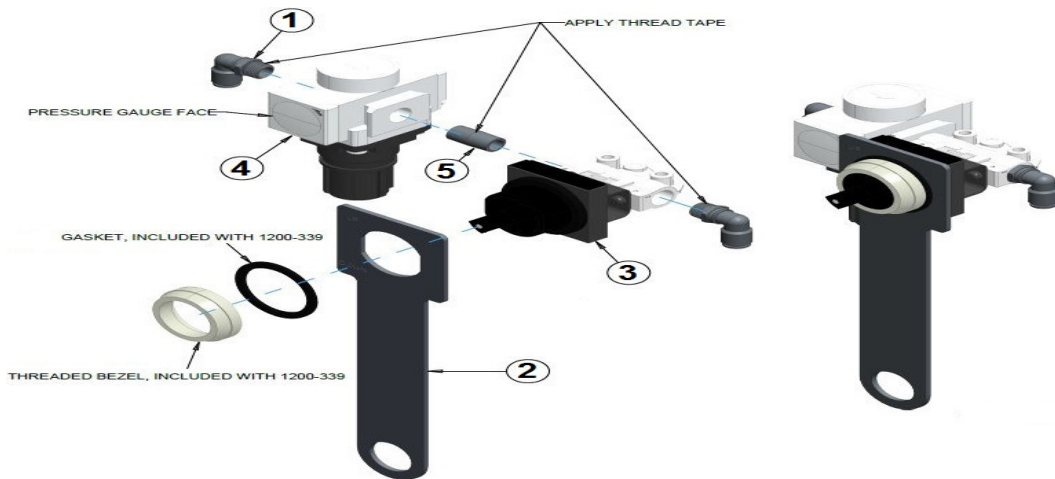

ITEM	PART NUMBER	DESCRIPTION	QUANTITY
1	1200-323	Male 90 Swivel, 1/4 tube to 1/8 NPT	2
2	1200-338	Valve Mount	1
3	1200-339	Selector Valve	1
4	1200-340	Regulator	1
5	1200-341	1/8" Close Pipe Nipple	1

1200-103 PARTS IDENTIFICATION

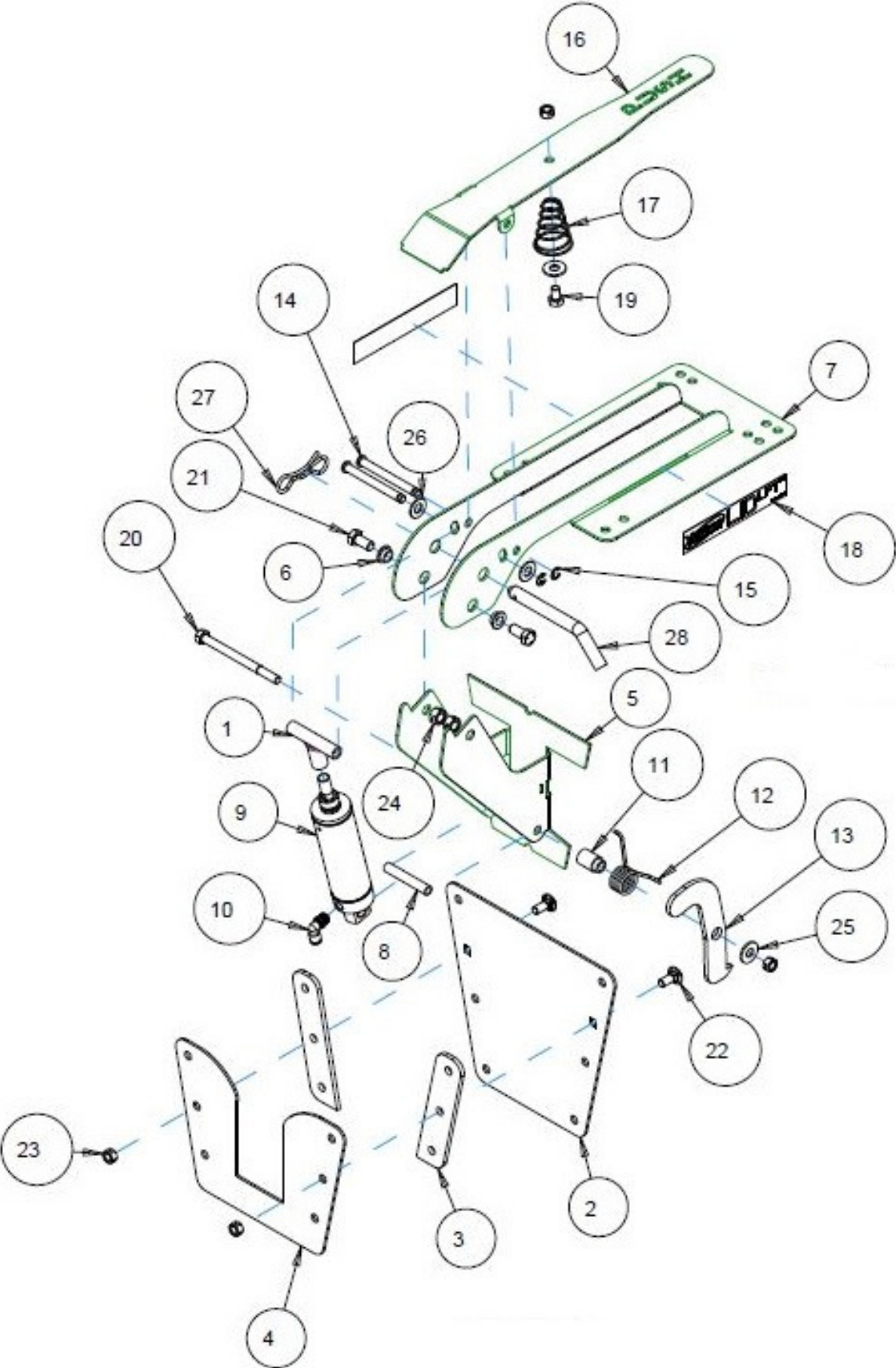

1200-103 PARTS IDENTIFICATION

ITEM	PART NUMBER	DESCRIPTION	QUANTITY
1	1200-202	CYLINDER END W.A.	1
2	1200-315	MOUNT PLATE	1
3	1200-316	SPACER	2
4	1200-317	LOCK PLATE	1
5	1200-318	CYLINDER MOUNT	1
6	1200-319	FLANGED SLEEVE BEARING, BRONZE	2
7	1200-320	LID PLATE	1
8	1200-321	SPACER	1
9	1200-322	AIR CYLINDER	1
10	1200-323	MALE 90 SWIVEL, ¼ TUBE TO 1/8NPT FITTING	1
11	1200-326	SPRING MANDREL	1
12	1200-327	LATCH SPRING	1
13	1200-328	LATCH	1
14	1200-329	CLEVIS PIN, GROOVED	2
15	1200-330	SIDE-MOUNT RETAINING RING	2
16	1200-331	LID HANDLE	1
17	1200-332	LID LATCH SPRING	1
18	1200-333	DECAL, LID LIFT	2
19	2502-194	5/16 – 18 X ½ HHCS GR 5 ZP	1
20	2502-224	5/16 – 18 X 4 HHCS GR 5 ZP	1
21	2502-230	3/8 – 16 X ¾ HHCS GR 5 ZP	2
22	2505-205	5/16 – 18 X ¾ CAR BOLT GR 5 ZP	2
23	2520-205	5/16 – 18 LOCK HEX NUT, GR A, ZP	4
24	2520-255	3/8 – 16 LOCK HEX NUT ZP	2
25	2526-201	5/16 STD FLATWASHER ZP	2
26	2526-253	3/8 SAE FLATWASHER ZP	2
27	2570-448	.120 BOWTIE LOCKING COTTER PIN ZP	1
28	2965-305	PIN, FURROWING ATTACHMENT ZP	1

TROUBLESHOOTING

<u>Problem</u>	<u>Cause</u>	<u>Corrective Action</u>
Lids will not raise	<ol style="list-style-type: none"> 1. insufficient Air 2. regulator Set Incorrectly 3. valve Not Open 4. Lids catching on hopper 	<ol style="list-style-type: none"> 1. engage the compressor or pinched airline 2. adjust the regulator 3. flip the switch to open the valve 4. inspect for remnants of latches & grind flat
Compressor will not run	<ol style="list-style-type: none"> 1. breaker Tripped at battery 2. insufficient power 3. switch set to OFF 4. worn compressor 	<ol style="list-style-type: none"> 1. reset 40A breaker at the battery 2. check all power connections 3. flip switch to ON 4. replace compressor

NOTES

NOTES

Our name Is getting known

Just a few years ago, Yetter products were sold primarily to the Midwest only. Then we embarked on a program of expansion and moved into the East, the South, the West and now north into Canada. We're even getting orders from as far away as Australia and Africa.

So, when you buy Yetter products . . .you're buying a name that's recognized. A name that's known and respected. A name that's become a part of American agriculture and has become synonymous with quality and satisfaction in the field of conservation tillage.

Thank you.

YETTER MANUFACTURING CO.
Colchester, IL 62326-0358 • 309/776-4111
Toll Free 800/447-5777
Fax 309/776-3222
Website: www.yetterco.com
E-mail: info@yetterco.com